



# ANLY TIMER

## TRD / ARD STAR- DELTA TIMER



### CHARACTERISTIC :

- Design for induction motor starter (Y- $\Delta$ )
- Made-to-order Y-to- $\Delta$  change-time from 0.1S to 0.5S
- Y-to- $\Delta$  change-time variable from 0 to 1S\*
- Short reset time for repeat operations
- 30S and 60S standard time ranges
- CE certified

Note: "\*" indicates applicable to TRD-NC series only

### SPECIFICATION :

Operating voltage	AC(V): 110, 220, 240
Allowable operating voltage range	85~110% of rated operating voltage
Rated frequency	50 / 60 Hz
Contact rating	250VAC 5A (resistive load)
Reset time	TRD MAX 0.3s ARD MAX 0.2s
Power consumption	Approx. 3VA
Life	Mechanical: 5,000,000 times Electrical: 100,000 times
Ambient temperature	-10 ~ +50°C (without condensation & freezing)
Ambient humidity	MAX 85% RH (without condensation)
Altitude	MAX 2000m
Weight	TRD-N/NT/NC Approx. 230g TRD-ND/NDT Approx. 210g ARD Approx. 160g

### TYPE SELECTION :

Type	TRD-N	TRD-NT	TRD-NC	ARD	TRD-ND	TRD-NDT
Time range	30s, 60s Variable				1 ~ 63s DIP switch setting	
Change time	Standard 0.1s		Variable 0~1s	Standard 0.1s	Standard 0.1s	
Connection	N Type	T Type	N Type	ARD	N Type	T Type
Dimensions	61H x 49W x 70D			50H x 40W x 57.5D	61H x 49W x 70D	

## CONNECTION :

N Type

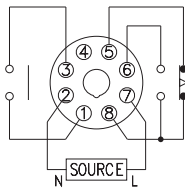

T Type



ARD

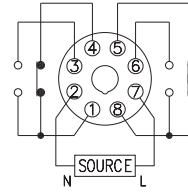

## TIMING CHART :

N Type

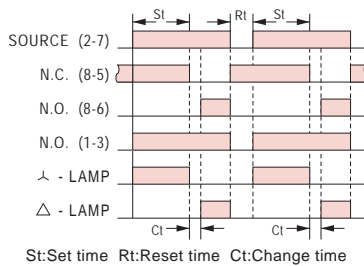

T Type

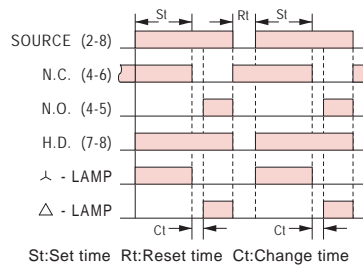

ARD

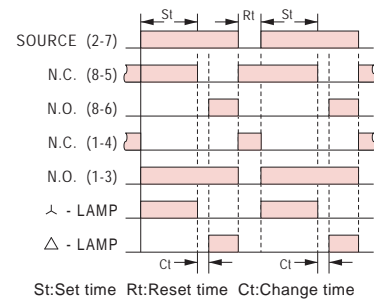

## DIMENSIONS : (mm)

TRD N type(Surface Mounting): Using 8PFA Socket

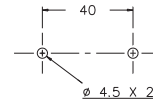
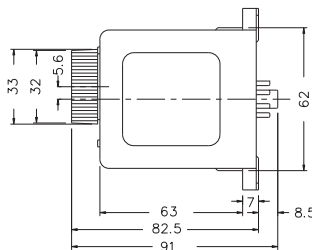
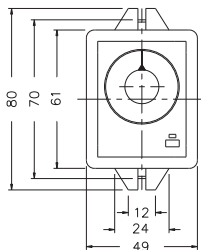

ARD N type(Surface Mounting): Using PF085A Socket & FH-3

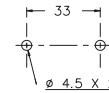
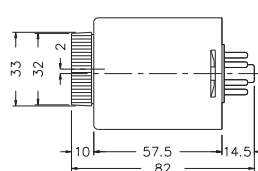
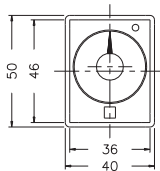

Tolerance:±0.1

## ANLY ELECTRONICS CO., LTD.

<http://www.anly.com.tw>

**TAIWAN MAIN OFFICE : ANLY ELECTRONICS CO., LTD.**

No.19, Lane 202, Fushou St., Xinzhuang Dist., New Taipei City 242, Taiwan  
TEL: +886-2-2996-3202 FAX: +886-2-2996-2017

**HONG KONG OFFICE : ANLY ELECTRONICS (HK) LTD.**

Flat K, 13/F, Edward Mansion, 141 Prince Edward Road W., Kowloon, Hong Kong  
TEL: +852-2397-2505 FAX: +852-2397-6080

**CHINA OFFICE : ANLY TECHNOLOGY (WUXI) CO., LTD.**

2F, Building A, Plot 1, No. 28, Zhanhong Rd., Xinwu Dist., Wuxi, Jiangsu, P.R.China  
TEL: +86-510-85304801~3

**MALAYSIA OFFICE : JUSTY ELECTRONICS (M) SDN. BHD.**

No.1, Jalan 6/89B, Kawasan Perindustrian Trisegi, Batu 3 1/2 Off Jalan Sungei Besi, 57100 Kuala Lumpur, Malaysia  
TEL: +60-3-7983-5758 FAX: +60-3-7981-5052

**INDONESIA OFFICE : PT. ANLY ELECTRONICS INDONESIA**

Jl. Pangeran Jayakarta 117/B9, Jakarta Pusat, 10730 Indonesia  
TEL: +62-21-624-8436 FAX: +62-21-626-1228